

Passionate about Particulate

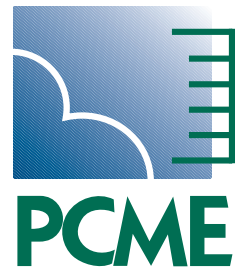

Leak Alert 73

ELECTRODYNAMIC™
INSIDE

Dust

Leak

Monitors

Filter Leak Monitor
with optional
self checks



- Ergonomic robust industrial design combines sensor and user interface functionality in single transmitter
- Selection of automatic Quality Assurance tests for improved performance
- Supports simple and flexible configuration via internal keypad/display or remote PC software



Certificate No: 9389

applications

System Description and Product Range

The Leak Alert 73 is particularly suited for use on fabric filter type dust collectors (baghouses) and provides reliable and robust monitoring of particulate leaks from bags. With its compact cost efficient transmitter design, pragmatic and reliable monitoring can now be provided for all types of industrial bagfilters. The instrument benefits, first from PCME's unique *ElectroDynamic™* Probe Electrification technology, secondly advanced features enabling The Leak Alert 73 to be configured for all types of bagfilters irrespective of cleaning sequence and finally a choice of field upgradeable options to provide quality assurance (QA) features for the user. The Leak Alert 73 is part of the PCME Leak Alert family of products.



Principles of Operation

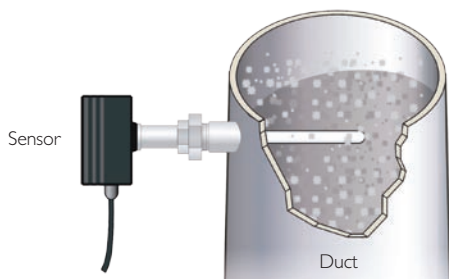

The Leak Alert 73 combines advanced signal processing techniques with PCME's unique *ElectroDynamic™* Probe Electrification technology. When the sensing probe is installed after the bagfilter, particles in the airstream interact with the sensing rod to induce a charge signature. The resulting signal is filtered electronically to reject signals outside a defined frequency range (including the dc Triboelectric signal) which makes the instrument less susceptible to changes in particle velocity and to virtually eliminate the effect of any particle contamination on the rod. In bagfilter applications the instrument provides a robust signal proportional to dust emissions which is used to monitor and detect bag leaks. The instrument has the necessary features to discriminate between the variation in dust due the bag cleaning sequence and real leak conditions.

Advanced Features

The Leak Alert 73 provides powerful bagleak capability based on the following standard features:

Bag leak monitoring performance

- High quality leak response with sufficient dynamic range and time response to track emissions from single and multi-compartment pulse cleaned bagfilters
- Instrument drift and minimum detection level below 0.1 mg/m^3 with leak monitoring to 500 mg/m^3
- Fully configurable warning alarm, limit alarm levels with independent alarm delay
- Convenient bag leak output range scaled 0-100%. Option for scaling in defined units (user selectable)

Designed for practical bagfilter issues

- Standard Category 3 instrument suitable for ATEX dust zone 22 (see Category 1 option for zones 20 and 21)
- Inbuilt surge protection to counter effects of indirect lightning
- Instrument inhibit connection used to disable rain detection when plant not running. Alternatively connector may be used for marker Pulse from bag cleaning cycle
- Industrially hardened enclosure and sensor mechanics provides convenient connections to plant allowing armoured cable use
- Can be powered directly from Mains power supply 110/230VAC (24VDC option)

Powerful user Interface

- Digital display and keypad within instrument
- Instrument set-up via internal keypad or PC laptop (optional software required)
- Intuitive multilevel user interface (user set-up, engineering set-up) with password protection
- Separate tri colour status LEDs and alarms for power, emission alarms and instrument self-checks

Leak Alert Monitors Bag Leak Conditions

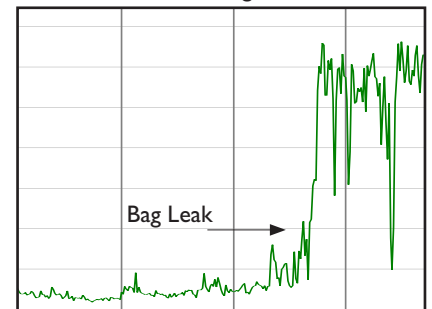

Leak Alert 73 with lid open showing 3 LEDs, display and internal set up keys

specifications

User selectable added value options

The Leak Alert 73 is also provided with a full choice of user selectable added value features.



Automatic insulator contamination detection

Electrodynamic sensors are tolerant to dust contamination of the sensor rod (unlike Triboelectric systems) due to the non-contact measurement principle, however, build-up of conductive material across the insulator at the base of the rod can lead to error. (as with all charge electrification systems). For standard dry dust collector applications, contamination is unlikely, but a possibility. The detection option provides a reliable method for detecting insulator contamination and hence improve Quality Assurance. (For applications where water condensation is likely, PCME's patented insulated sensor is a preferred option).

Automatic electronics zero and reference drift detection

Simulated dust signals are automatically injected into the front end of the sensor electronics to ensure any electronic and signal measurement malfunction is automatically detected. This Quality Assurance Feature checks that the sensor electronics are operating to specification.

User scaling of display

Of assistance to plant personnel wishing to manually scale the display to an approximate known dust level rather than a relative % level.

Specifications

Feature	Specification
Ambient temperature (stack limit is 250°C or 400°C)	-25°C to 55°C
Stack connection (at sensor connection)	1 ½" BSP
Enclosure rating	IP-65 (with hinged lid closed)
Power Requirements	110/230VAC 50/60Hz or 24VDC
Outputs	Isolated 4-20mA (500 ohm) Warning alarm relay (SPST 1A@24VDC) Fail safe Emission alarm relay (SPST 1A@24VDC) Fail safe RS-232 output - option RS-485 (Modbus) - option
Inputs	Plant stop signal (output to zero when plant is off)
External LED x3	Power/ sensor OK Warning and limit alarm Self check status (options)
User set up	4 digit display and set up buttons
Cable entries	3 x M20 gland/conduit entries
Air purge connection	½" BSP*

*option: requires external supply of 0.5 liters/min of dry, clean, oil free instrument air

Upgrade path to Leak Locate 880

The Leak Alert 73 may be upgraded to the Leak Locate 880 instrument. This enables plant operators to locate the position of failing bag rows in the dust collector, hence reducing bag replacement costs and minimising the time diagnosing dust collector faults.

Physical Dimensions

250°C Standard Sensor

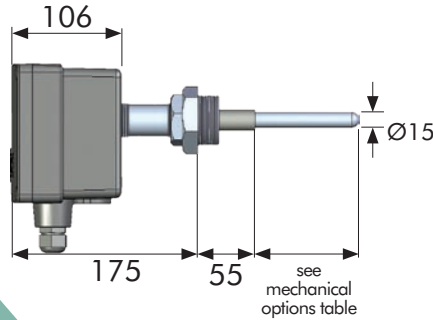
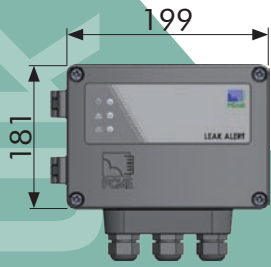

Duct Connection

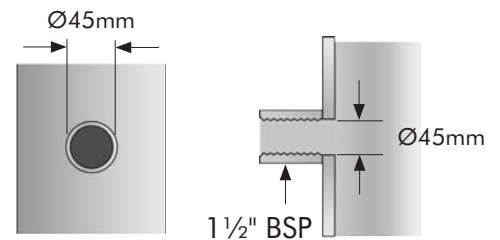

400°C Standard Sensor

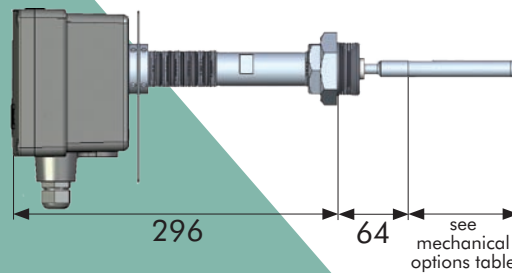
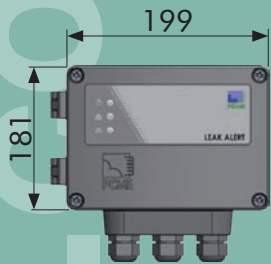

Optional PC Software

PC Software	Purpose
Leak Alert set up	For instrument configuration by PC
Service diagnostic	For advanced service diagnostics
PCView*	For viewing emissions on PC

*requires RS-232 output or RS-485 option

Order Code

LeakAlert 73 - I 2 3 - A B C D E F G H

Example	I	2	3	A	B	C	D	E	F	G	H
Leak Alert 73 -	250C	R0500	S	SC	0	%	X22	AC	485	0	FLY

Mechanical Options (I 2 3)

	Requirement	Option	Code
1	Stack Temperature	Up to 250°C Up to 400°C	250C 400C
2	Rod Length	0100mm to 1000mm	Rxxxx
3	Rod material	Stainless Insulated (PTFE)	S I

Electrical Options (A B C D E F G H)

	Feature	Option	Code
A	Contamination check	None Short Circuit Check	0 SC
B	Electronic Self checks	None Electronic Zero and Reference Checks	0 E
C	Scaling method	Percentage of 4-20mA Scaling factor	% SF
D	ATEX category	Category 3 dust (zone 22) Category 2 dust (zone 21)	X22 X21
E	Power option	115/230V AC 24V DC	AC 24V
F	RS485 Data output	4-20mA only 4-20mA and RS485	0 485
G	RS232 Data output	4-20mA only 4-20mA and RS232	0 232
H	Connector for RS232 or RS485	Internal connector External flylead	0 FLY

About PCME Ltd

As a progressive environmental Company, PCME specialises in particulate measurement for industrial processes. With a worldwide reputation for reliability, innovation and technological excellence, the Company produces equipment for concentration and mass monitoring for regulatory, environmental and process control requirements. A dedicated team of qualified application and sales engineers is always on hand and should be consulted in the selection and usage of the most suitable equipment for any particulate application.



PCME Ltd
 Clearview Building, 60 Edison Road
 St. Ives, Cambs PE27 3GH UK
 Tel: Int +44 (0)1480 468200
 Fax: Int +44 (0)1480 463400
 E-mail: sales@pcme.co.uk

Contact your national or area sales and service office